



Extension Ladder Telescopic

Instruction Manual

For models:

2.6m, 9 Rung/Sections Telescopic Ladder

2.9m, 10 Rung/Sections Telescopic Ladder

3.2m, 11 Rung/Sections Telescopic Ladder

3.8m, 13 Rung/Sections Telescopic Ladder

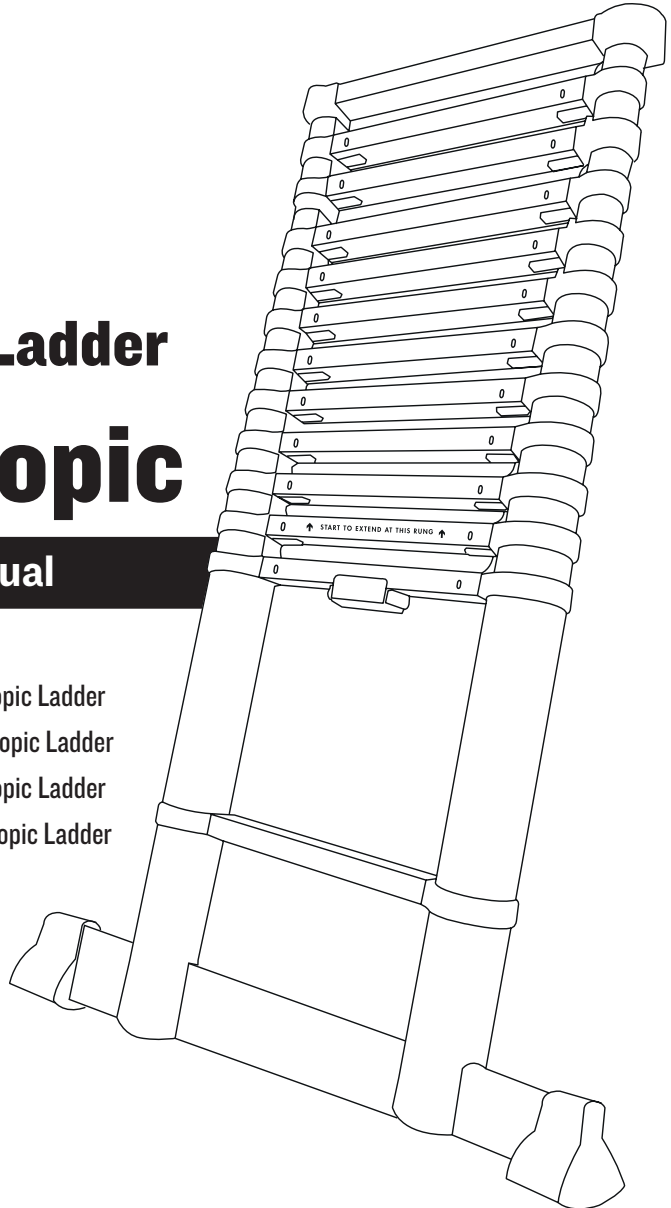

CONTENTS

Leaning Ladder Guide	1
Operating and Usage Instructions	4
Quick Operating Guide	10
Ladder Safety Check	12
Guarantee.	13

LEANING LADDER GUIDE

Every month, more than a thousand people need hospital treatment because of accidents at home involving ladders... **ABOVE ALL BE CAREFUL**

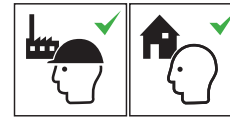

EN131
Ladder suitable for
Professional Use



WARNING!
Fall from the ladder

BEFORE USE

- Read all instructions on and accompanying the ladder.



- Inspect the ladder after delivery. Before every use visually check the ladder is not damaged and is safe to use.



- Do not use a damaged ladder.

- Do not use the ladder if you are not fit enough. Certain medical conditions or medication, alcohol or drug abuse could make ladder use unsafe.



- Ensure the ladder is suitable for the task.

- Visually check the ladder is not damaged and is safe to use at the start of each day when the ladder is to be used.



- Inspect ladder feet.



- For ladders that require a stabiliser do not use the ladder until the stabiliser bar has firstly been fully attached and secured to the ladder.

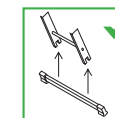

- Do not use the ladder if contaminated, e.g. with wet paint, mud, oil, water or snow.
- Prevent damage of the ladder when transporting e.g. by fastening and ensure they are suitably placed to prevent damage.
- For professional users regular periodic inspection is required.
- For professional use, a risk assessment shall be carried out respecting the legislation in the country of use.
- Do not modify the ladder design.

POSITIONING & ERECTING THE LADDER

- When positioning the ladder, take into account risk of collision with the ladder e.g. from pedestrians, vehicles or doors. Secure doors (not fire exits) and windows where possible in the work area.

- Warning! Electricity hazard. Identify any electrical risks in the work area, such as overhead lines or other exposed electrical equipment and do not use the ladder where electrical risks occur.





LEANING LADDER GUIDE

- Do not erect ladder on contaminated ground. Ladders shall not be positioned on slippery surfaces (such as ice, shiny surfaces or significantly contaminated solid surfaces) unless additional effective measures are taken to prevent the ladder slipping or ensuring contaminated surfaces are sufficiently clean. 

- Do not use the ladder on an unlevel or unfirm base. 

- Ladder shall be on an even, level and unmovable base.

- Do not lean the ladder against unsuitable surfaces. Leaning ladder should lean against a flat non-fragile surface and should be secured before use e.g. tied or use of a suitable stability device. 

- Only use the ladder in the direction as indicated. 

- Ladder shall be erected at the correct position, such as the correct angle for a leaning ladder (angle of inclination approximately 1:4) with the rungs or treads level. 

- Keep the arrow vertical for correct working angle. 

- All locking mechanisms for all extended rungs/steps shall be checked and be locked before use. 

- Ladder should be stood on its feet, not the rungs or steps.

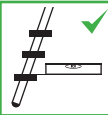
- Leaning ladders with steps, shall be used that the steps are in a horizontal position. 

- Secure ladder at the top and bottom wherever possible. If not, station someone at the foot of the ladder.

- Do not move a ladder while standing on it.

- Ladder shall never be repositioned from above.

USING THE LADDER

- Do not exceed the maximum total load (load includes users, tools, materials, etc.). 

- Maximum number of users on the ladder. 

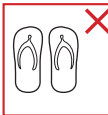
- Do not wear unsuitable footwear when climbing a ladder. 

- Do not ascend or descend unless you are facing the ladder. 

- Keep a secure grip on the ladder when ascending and descending. Maintain 3 points of contact whilst working from a ladder or take additional safety precautions if you cannot. 

- Do not stand on the top three steps/rungs of a leaning ladder. 

LEANING LADDER GUIDE

- Do not stand on the last metre of a telescopic ladder. 

- Do not overreach, user should keep their belt buckle (navel) inside the stiles and both feet on the same step/rung throughout the task. 

- Avoid work that imposes a sideways load on ladders, such as side-on drilling through solid materials. 

- Do not carry equipment which is heavy or difficult to handle whilst using a ladder. 

- Equipment carried while using a ladder should be light and easy to handle.

- Leaning ladders used for access to a higher level shall be extended at least 1m above the landing point and secured if necessary. 

- Use non-conductive ladders for unavoidable electrical work.

- Secure doors (not fire exits) and windows where possible in the work area.

- Do not use the ladder outside in adverse weather conditions, such as strong wind.

- When outdoors, be cautious in windy conditions.

- Ladders should only be used for light work of a short duration.

- Do not spend long periods on the ladder without regular breaks (tiredness is a risk).

- Do not use the ladder as a bridge. 

- Do not bring your hands/fingers in rung area (area of shearing) when bringing the ladder in to its possible position of use. 

- Take precautions against children playing on the ladder.

OPERATING INSTRUCTIONS

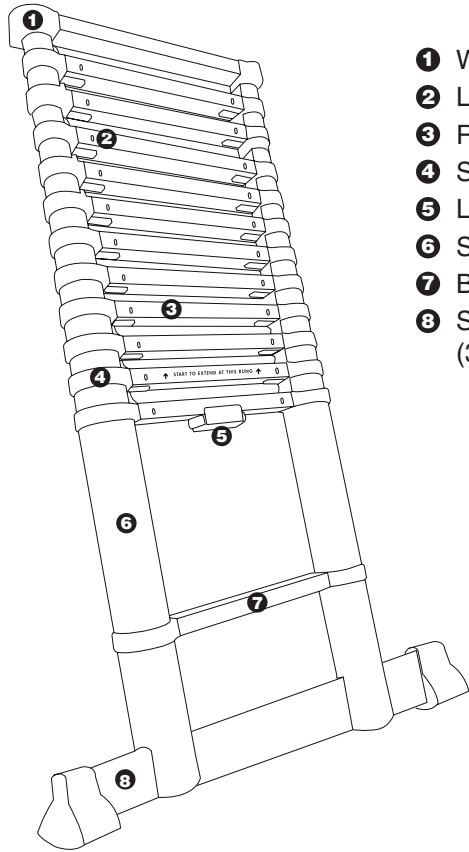

- ❶ Wall Bumper
- ❷ Lock Indicator
- ❸ Rung
- ❹ Support Ring
- ❺ Lock Release
- ❻ Stile Tube
- ❼ Bottom Rung
- ❽ Stabiliser Bar (3.2m & 3.8m models only)

OPERATING AND USAGE INSTRUCTIONS

IMPORTANT – read all instructions carefully before attempting to operate or use the ladder. The ladder should be inspected after delivery and before every use to confirm condition and operation of all parts.



Do not open / extend the ladder from either a middle or the top ladder section. The ladder sections may not fully lock which may lead to injury.

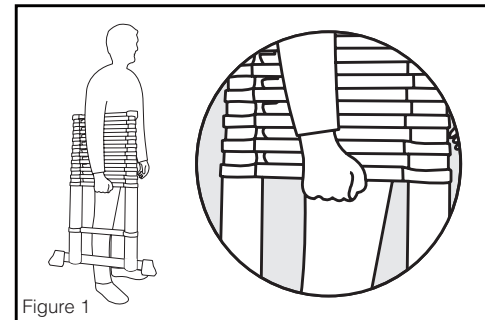

Figure 1

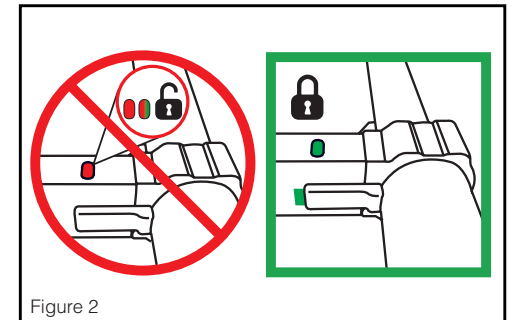

Figure 2

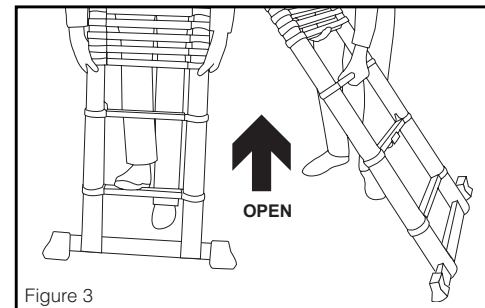

Figure 3

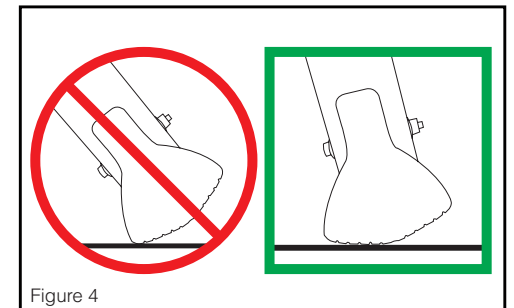

Figure 4

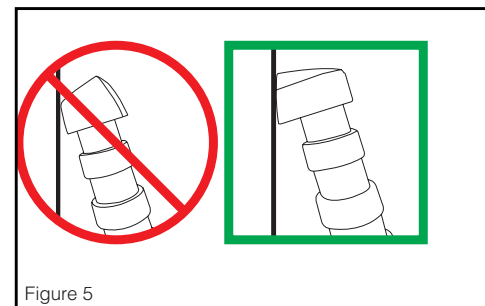

Figure 5

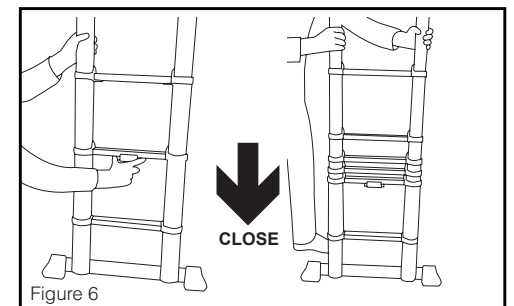

Figure 6

OPERATING AND USAGE INSTRUCTIONS

1. SAFETY PROCEDURE

- 1.1 **ALWAYS** read and follow these and all operating and safety instructions supplied with and affixed to the ladder and ensure the ladder is suitable for the task to be performed.
- 1.2 **ALWAYS** transport the ladder fully closed and hand carry under arm gripping the underside of the ladder lock release housing on the underside of rung 2 (see figure 1).
- 1.3 **ALWAYS** treat this precision built product with care. Open and close the ladder in a slow and careful manner. If a stile tube is dented or damaged the ladder may be difficult to operate or may completely malfunction.
- 1.4 **ALWAYS** ensure that you are fit enough to use a ladder. Certain medical conditions or medication, alcohol or drug abuse could make ladder use unsafe.
- 1.5 **ALWAYS** deploy the ladder at the correct angle (75 degrees to the horizontal) and upon a firm and level standing surface.
- 1.6 **ALWAYS** support the top of the ladder via its safety grip wall bumpers and never the stile tubes or rungs which may be damaged as a result.
- 1.7 **ALWAYS** check that the ladder lock indicators below each extended section are 'full green' and ensure that all related ladder locks are correctly fully engaged before attempting to climb the ladder (see figure 2).
- 1.8 **ALWAYS** secure / tie the top of the extended ladder whenever possible. **NEVER** use the ladder outdoors in adverse weather conditions (such as strong wind).
- 1.9 **ALWAYS** wear suitable footwear when climbing the ladder.
- 1.10 **ALWAYS** deploy the ladder forwards and face the front of the ladder and keep a secure grip on the ladder when ascending and descending.
- 1.11 **ALWAYS** ensure that any equipment carried whilst using the ladder is lightweight and easy to handle.
- 1.12 **ALWAYS** maintain a handhold whilst working from the ladder or take additional precautions if you cannot do so.
- 1.13 **ALWAYS** avoid applying excessive side loading whilst working from the ladder (e.g. during the drilling into brick or concrete).
- 1.14 **ALWAYS** use the ladder for light work of short duration only. **NEVER** spend long periods on the ladder without regular breaks (tiredness is a risk).
- 1.15 **ALWAYS** secure doors (not fire doors) and windows within the work area whenever possible.
- 1.16 **ALWAYS** keep the ladder clean. Wipe the stile tubes occasionally with a clean, dry cloth. Paint or other 'foreign' material will impede the telescoping action and must be cleaned off immediately.

OPERATING AND USAGE INSTRUCTIONS

- 1.17 **ALWAYS** store the ladder fully closed and indoors. Damp conditions could adversely affect the condition and operation of the product.
- 1.18 **ALWAYS** carry out a risk assessment (respecting the legislation in the country of use) before using the ladder for Professional work.
- 1.19 **NEVER** use a damaged ladder.
- 1.20 **NEVER** carry, operate or use the ladder in or near live electrical environments. This ladder can conduct electricity (use instead an alternative electrically non-conductive ladder).
- 1.21 **NEVER** use the ladder in dirty / dusty environments. The ingress of 'foreign' material will impede the telescoping action.
- 1.22 Ladders shall **NEVER** be positioned on slippery surfaces (such as ice, shiny surfaces or significantly contaminated solid surfaces) unless additional effective measures are taken to prevent the ladder slipping or ensuring contaminated surfaces are sufficiently clean.
- 1.23 **NEVER** immerse any part of the ladder in water which will damage the product and impede the telescoping action.
- 1.24 **NEVER** use the ladder back to front, upside down or horizontal (as a bridge or saw horse etc.) which may cause product damage and / or personal injury.
- 1.25 **NEVER** climb above the fourth rung down from the top of the ladder. Note:
- When the ladder is not being used fully extended, the top group of rungs of the unextended sections represent the 'single' top rung.
 - The uppermost bar of this ladder is not classified, nor shall it be counted, as a rung.
- 1.26 **NEVER** apply a load that exceeds the maximum load rating for the product of 150kg (23.6st).
- 1.27 **NEVER** touch or tamper with the ladder lock release mechanism whilst the ladder is in use.
- 1.28 **NEVER** use the extended ladder if there is any doubt that any of the extended section locks are fully engaged.
- 1.29 **NEVER** partly retract / reduce the ladder to a shorter length **ALWAYS** retract all sections and fully close the ladder first and then re-open / extend the ladder to the desired shorter length.
- 1.30 **NEVER** overreach or lean backwards when standing on / using the ladder. **ALWAYS** keep belt buckle / navel within ladder stiles and both feet on the same rung throughout the task.
- 1.31 **NEVER** push / pull the ladder to move its position (descend the ladder first and then move the ladder to its required location).
- 1.32 **NEVER** step off the ladder at a higher level without additional security (tying the extended ladder or use of a suitable stability device).
- 1.33 **NEVER** allow children to climb or play on or near to the ladder.

OPERATING AND USAGE INSTRUCTIONS

2. OPENING / EXTENDING AND DEPLOYING THE LADDER

- 2.1 Before using the ladder it shall be checked that all locking mechanisms are working properly. If the mechanism is not working properly, do not use the ladder.
- 2.2 Stand and support the closed / retracted product vertically and upon a firm / level surface and then place one foot centrally upon the fixed bottom rung (rung 1) to stabilise the ladder (see figure 3).
- 2.3 Note that the ladder must be opened / extended from the lowest extendable section and not from either a middle or the top section
- 2.4 Using both hands, lightly hold the stile tubes below the black support rings of rung 3 (the rung of the first / lowest extendable ladder section) and then pull up and fully extend the section (see figure 3).
- 2.5 Repeat step 2.4 and extend each further ladder section (one at a time) until the desired ladder length is reached (note that it will eventually become necessary to lower the extended ladder to enable higher ladder sections to be extended).
- 2.6 Check all ladder lock indicators (immediately below each extended section) are showing 'full green' (see figure 2).
- 2.7 Note the slope of the ladder feet and the location of the safety grip wall bumper square pads and then correctly deploy and support the extended ladder forwards and at an angle of 75 degrees to the horizontal (see figures 4 and 5).
- 2.8 Ensure that the deployed ladder is secure by placing the ladder feet upon a firm and level surface and both safety grip wall bumper pads against a firm vertical surface (e.g. a wall). Whenever possible, secure / tie the top of the extended ladder.
- 2.9 Take special care in adverse weather conditions (e.g. strong winds). If in doubt, do not risk your personal safety and postpone the use of the ladder.

3. CLOSING / RETRACTING THE LADDER

- 3.1 Stand and support the open / extended product upright by firmly holding one of the stile tubes part way up the ladder with one hand and then using your other hand, fully depress and then release both ladder lock release buttons (see figure 6) to unlock the lowest extended ladder section (note that the ladder sections will not descend / self-close when these buttons are depressed).
- 3.2 Using both hands, lightly hold the outside stile tubes of the ladder and carefully / slowly pull down all ladder sections (note that the lowest extended section will sequentially fully retract / close first which will then automatically unlock the next extended section).
- 3.3 Whenever partly reducing the length of the extended ladder, always follow steps 3.1 and 3.2 first to fully retract / close the ladder

OPERATING AND USAGE INSTRUCTIONS

and then follow steps 2.1 to 2.6 to re-extend the ladder to the desired reduced length.

4. HANDLING, STORAGE AND MAINTENANCE

- 4.1 This ladder is a precision built product and should be handled with care, stored in suitable conditions and maintained in full working order to continue providing safe and reliable service.
- 4.2 Transport the ladder fully closed and hand carry under arm. With one hand hold the underside of the ladder lock release housing on the underside of rung 2 (see figure 1), support / carry the product with your arm straight and steady the ladder with your other hand.
- 4.3 Open and close the ladder in a slow and careful manner.
- 4.4 Avoid striking the product against another object. If a stile tube is dented or damaged the ladder may be difficult to operate or may completely malfunction.
- 4.5 Store the ladder fully closed and vertical, stood upon both its feet and leant against a vertical surface.
- 4.6 Always store the ladder indoors. Damp conditions could adversely affect the condition and operation of the product.
- 4.7 Keep the ladder clean. Wipe the stile tubes occasionally with a clean, dry cloth. Wipe and dry the product immediately following exposure to wet conditions (e.g. rain). Paint or other 'foreign' material will impede the telescoping action and must be cleaned off immediately.
- 4.8 If any stiffness in the telescoping action develops, firstly wipe the stile tubes with a clean, dry cloth, then apply a small amount of silicone spray and wipe any excess off with a clean cloth.
- 4.9 Replace worn (or damaged) ladder feet and safety grip wall bumpers before they are worn smooth. Only use genuine original replacement parts to ensure your safety.
- 4.10 Except to replace ladder feet and safety grip wall bumpers, do not attempt to disassemble or repair the product yourself. All repairs and other maintenance shall only be carried out by a competent person in accordance with the manufacturer's instructions. For any assistance relating to this product contact the Customer Helpline on 01621 745 900.
- 4.11 For Professional users; regular periodic inspection of the ladder is required.

QUICK OPERATING GUIDE

Read these instructions before using the ladder.
Always keep these instructions with the ladder.

1 Always extend the ladder from the bottom.

Start to extend the ladder by pulling upward the two black support rings of the third rung from the bottom until the section locks. Repeat this procedure for each next section until the desired ladder length is reached.

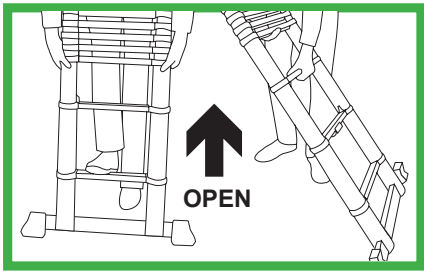

2 Check and ensure that all extended sections are fully locked and that the lock indicators are showing full green. Never attempt to use or climb the ladder if any of the lock indicators below each extended section are showing full red or half red / half green.

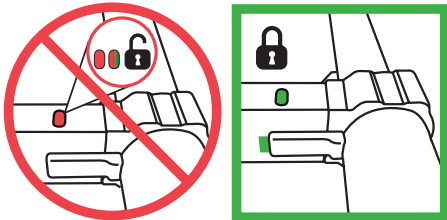

3 Note the sloped shape of the ladder feet and place the extended ladder the correct way round (forwards) at an angle of 75 degrees to the ground and supported at the top. Never climb the rear of the ladder and never climb the ladder when placed the wrong way round (reversed).

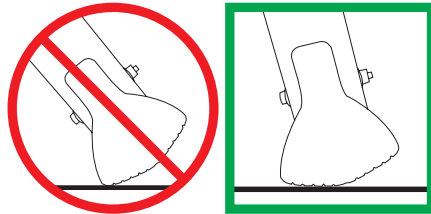

4 Place the square pads of the safety grip wall bumpers at the top of the ladder against a suitable support (e.g. a wall). The bumpers provide grip to give stability. Never support the ladder by the rungs or stile tubes.

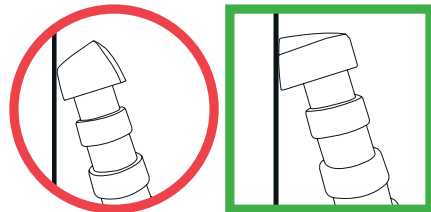

QUICK OPERATING GUIDE

5 Never attempt to climb the ladder if the sections are in the wrong position and the distance between all rungs of the extended ladder are not the same. Ensure that all sections are opened in sequence and are fully extended and locked.

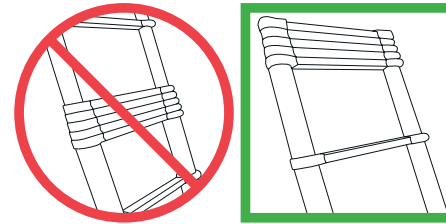

6 To close the ladder support the ladder in an upright position with one hand and depress and then release both ladder lock release buttons with your other hand. Using both hands, hold outside of the stile tubes and pull the sections downward. The lowest extended section will close first which will automatically unlock the next extended section. Continue to pull down the sections until the ladder is fully closed.

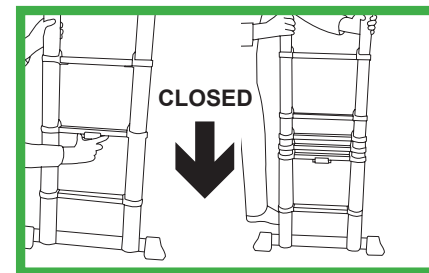

Also read and follow the full instructions supplied with the ladder and the safety labels affixed to the ladder.

LADDER SAFETY CHECK

IMPORTANT – Professional users and equipment providers to professional users (e.g. employers) should engage in proper training such as the ladder association ladder inspection course. Please contact the customer helpline on 01621 745 900 for more information.

1. REPAIR, MAINTENANCE & STORAGE

- Repairs and maintenance shall be carried out by a competent person and be in accordance with the producer's instructions.
- Ladders should be stored in accordance with the producer's instructions.
- Replacement spare parts are available to order online at wernerco.com.

2. LIST OF ITEMS TO BE INSPECTED

For regular inspections, the following items shall be taken into account-

CHECK:

- The stiles/legs (uprights) are not bent, bowed, twisted, dented, cracked, corroded or rotten.
- The stiles/legs around the fixing points for other components are in good condition.
- The fixings (usually rivets, screws or bolts) are not missing, loose or corroded.
- The rungs/steps are not missing, loose, excessively worn, corroded or damaged.
- The hinges between the front and rear sections are not damaged, loose or corroded.
- The locking stays horizontal, back rails and corner braces are not missing, bent, loose, corroded or damaged.
- The rung hooks are not missing, damaged, loose or corroded and engage properly on the rungs.
- The guide brackets are not missing, damaged, loose or corroded and engage properly on the mating stile.
- The ladder feet/end caps are not missing, loose, excessively worn, corroded or damaged.
- The entire ladder is free from contaminants (e.g. dirt, mud, paint, oil or grease).
- The rung locking catches are not damaged, sticking or jammed and are functioning correctly.

If any of the above checks cannot be fully satisfied, you should **NOT** use the ladder.

LADDER SAFETY CHECK

3. STORAGE

The important considerations when storing a ladder (not in use) should include the following:

- Is the ladder stored away from areas where it's condition could deteriorate more rapidly e.g. dampness, excessive heat, or exposed to the elements?
- Is the ladder stored in a position which helps it remain straight e.g. hung by the stiles on proper ladder brackets or laid on a flat clutter free surface?
- Is the ladder stored where it cannot be damaged by vehicles, heavy objects, or contaminants?
- Is the ladder stored where it cannot cause a trip hazard or an obstruction?
- Is the ladder stored securely where it cannot be easily used for criminal purposes?
- If the ladder is permanently positioned (e.g. on scaffolding), is it secured against unauthorised climbing (e.g. by children)?

GUARANTEE

Guarantee includes faults arising from defects in workmanship or materials except for -

- Ordinary wear and tear of the product.
- Damage caused by misuse or abuse of the product.
- Damage caused by failure to comply with all written warnings and instructions for the product.
- Damage caused by an attempted repair of the product.

Material - means a material or component used by Werner UK Sales & Distribution Ltd. in the manufacture of the product.

Workmanship - means the handling, assembly and manufacturing processes performed by or on behalf of Werner UK Sales & Distribution Ltd. in order to manufacture the product.



Werner UK Sales & Distribution Ltd.

Blackwater Trading Estate, The Causeway, Maldon, Essex, CM9 4LJ
WernerCo Hungary. Kft. 6000 Kecskemét, Szt. Istvan Krt. 19 Hungary

☎ +44 (0)1621 745900 ✉ uk.customercare@wernerco.com 🌐 wernerco.co.uk